

Fracture toughness of acrylic bone cements

C. T. WANG, R. M. PILLIAR*

Centre for Biomaterials, University of Toronto, 124 Edward Street, Toronto, Ontario M5G 1G6, Canada

Clinical experience has shown that fracture of PMMA-based bone cements is a significant factor in the failure of orthopaedic joint replacements. Earlier studies of the fracture toughness properties of bone cement have been limited to relatively large test specimens – ASTM standard test methods require the use of specimens with dimensions considerably larger than those associated with bone cement in clinical use. In this study, a miniature short-rod specimen was used to measure the fracture toughness (K_{IC}) of two bone cements (Simplex-P and Zimmer LVC). The dimension of our mini specimens approaches the cross-section of bone cements as used *in vivo*. The short-rod elastic-plastic fracture toughness test method introduced by Barker was utilized to ascertain the effect of specimen preparation and ageing in distilled water on fracture toughness. Our study indicated that slow hand-mixed specimens possess comparable fracture toughness to centrifuged specimens. After ageing in water, however, centrifuged and slow hand-mixed specimens are more fracture resistant than specimens prepared by mixing the cement quickly. An optimum void content for the bone cements studied was suggested by the experimental results; for Simplex-P bone cement it appeared to be less than 1.6% whereas it was between 1.6 and 3.6% for Zimmer LVC cement. Simplex-P bone cement also showed superior fracture toughness compared to Zimmer LVC cement after storage in water for 60 days at 37°C.

Nomenclature

D Mini short-rod specimen diameter.
 K_{IC} Plane-strain fracture toughness.
 P_c Critical load.
 p Plasticity factor.
 W Mini short-rod specimen length.

Y_m^* Minimum of the stress-intensity factor coefficient.
 ΔX_0 Distance between adjacent extrapolated loading curves at zero load.
 ΔX Distance between adjacent extrapolated loading curves at the average of the peak loads.

1. Introduction

Polymethyl methacrylate (PMMA)-based bone cement has contributed enormously to the success of orthopaedic joint replacements since its introduction in the 1960s. Ironically, bone cement is also a major cause of implant failure due to its relatively poor mechanical properties [1–11]. The loosening of femoral components of hip prostheses, generally associated with radiolucent zones at the cement–bone or cement–implant interface, has been shown to occur in 8 to 24% of total hip replacements in 4 to 7 y follow-up studies [3, 4, 12]. Fracture of the cement, although suspected in cases of loosening, has been difficult to identify unequivocally [3]. However, a significant number of these failures have been characterized by radiographic features that show definite evidence of cement fracture [4, 5, 7, 12–14].

Gruen *et al.* [4] reported a higher number of fractures of bone cement on the lateral (tensile) side compared to the medial (compressive) side of femoral hip implant components. This higher incidence of fracture on the tensile side is attributable to the poor tensile property of bone cement. Bilateral arthroplasties are

found to be especially vulnerable to bone cement fractures. In a study of 6649 patients, Weber and Charnley [7] reported a cement fracture rate of 41% (38 out of 92) for patients with bilateral hip implants. He postulated that the mechanical cause producing fracture of the cement is the “end-bearing” effect: as the prosthesis loosens in the cement mantle, the distal part of the cement becomes loaded in tension which leads to fracture.

Commercial PMMA is formed under high pressure and heat-cured to yield a strong nonporous product. Surgical PMMA (bone cement) utilizes methyl methacrylate polymer in powder form and liquid monomer which are hand-mixed and self-polymerizing. After curing, bone cements usually contain pores resulting from entrapment of air bubbles during mixing and local evaporation of monomer during the exothermic polymerization reaction [15]. The porous structure of the resulting bone cement contributes to its poor mechanical properties [16–21]. Centrifugation, ultrasound mixing, and vacuum mixing during bone cement formation have been studied [16, 17, 20, 22–30] as methods of reducing the porosity of the bone cement

*Author to whom all correspondence should be addressed.

in order to increase its mechanical properties. These studies have shown increased fatigue resistance [23, 27–29, 31–33] and strength [23–26, 31, 32] with decreased porosity.

A limitation of the earlier studies has been the use of test specimens with dimensions considerably greater than those associated with bone cement in clinical use. Typically, cross-sectional dimensions of cements used in fixing implant components are 2 to 4 mm. Cement mass is known to influence the temperature reached during curing due to the exothermic curing reaction [16, 34]. Curing temperature influences cement structure (porosity volume, size and distribution of pores [35, 36], average molecular weight, molecular weight distribution, residual monomer concentration [34]) and, therefore, its mechanical properties [34–38]. The use of larger specimens during fracture property assessment could, therefore, give information not representative of the material as used clinically.

We have used the miniature short-rod specimen and elastic–plastic analysis method described in a previous paper [39] to test bone cement specimens of a size more closely approximating the cross-sections used *in vivo*. This method of testing was chosen over the simpler linear-elastic analysis method for two reasons; (1) the reported nonlinear behaviour of PMMA requiring elastic–plastic testing and analysis methods (such as J-integral [40]), and (2) our mini specimen size may accentuate the plasticity of the material during testing.

The purpose of this study was to determine the effect of (1) different mixing methods and (2) *in vitro* ageing in distilled water on the fracture toughness properties of small bone cement specimens. In addition, the use of the miniature short-rod fracture toughness test with elastic–plastic testing and analysis for the evaluations of K_{IC} was demonstrated.

2. Experimental methods

2.1. Materials and specimen preparation

The materials tested were Surgical Simplex-P bone cement (Howmedica Inc., Rutherford, New Jersey), and Zimmer Low Viscosity Cement (LVC) (Zimmer Inc., Warsaw, Indiana). These two cements are widely available and used in North America. Both cements are two-component systems containing powder polymer and liquid monomer.

Notable differences between the composition of the two cements are (1) 2.8% styrene is copolymerized into 83.3% of the powder phase of Simplex-P cement [41], and (2) 10.0% of radiopaque barium sulphate

particles is added to the Zimmer LVC cement. The copolymerization of the small amount of styrene is said to improve processing characteristics, to impart radiation resistance, and possibly reduce temperature rise during polymerization [41]. It is not known what the effect of copolymerized polystyrene is on fracture resistance of PMMA, but polystyrene is conventionally considered a weaker material than PMMA [42].

The addition of 10% barium sulphate to Simplex-P cement has been shown to decrease tensile strength, transverse strength and modulus of rupture by approximately 10% [41]. An average decrease of 5% in compressive strength was found by Lee *et al.* [43] with the addition of radiopaque fillers in various bone cements. Improvement in fracture toughness of Simplex-P and Zimmer cements have been reported with the addition of BaSO₄ [44]. Studies on the effect of barium sulphate addition on the mechanical properties of Zimmer LVC cement have not, as far as we are aware, been reported.

Values of fracture toughness for these materials determined using conventional specimen geometries have been widely reported so that direct comparisons with the values determined by this study could be made.

The configuration of our mini short-rod specimen is shown in Fig. 1. The specimen is approximately 7 mm long and 4 mm diameter. A collar 9.5 mm diameter and 1 mm thick with two loading holes is formed as an integral part of the specimen front face. This collar facilitates loading of the small specimen. The chevron-shaped slot that is machined along the mid-plane of the specimen is approximately 0.25 mm wide.

Three types of test specimens were formed by mixing 8 g PMMA powder with 4 ml liquid monomer. The monomer and powder were mixed in a plastic mixing cup by hand using a stainless steel spatula. To prolong working time, the liquid monomer was pre-cooled in an ice bath for 15 min prior to mixing to form the controlled hand-mixed (CHM) and centrifuged (CFG) specimens. For the uncontrolled hand-mixed (UHM) specimens, the liquid monomer was used at room temperature and the two components of the bone cement were mixed at a high rate to achieve the fastest wetting of the powder. The mixture was stirred for approximately 1 min with an irregular mixing pattern and packed into PTFE moulds by gloved hand.

The controlled hand-mixed and the centrifuged specimens were moulded from cements that were mixed at a more or less constant rate of one cycle per

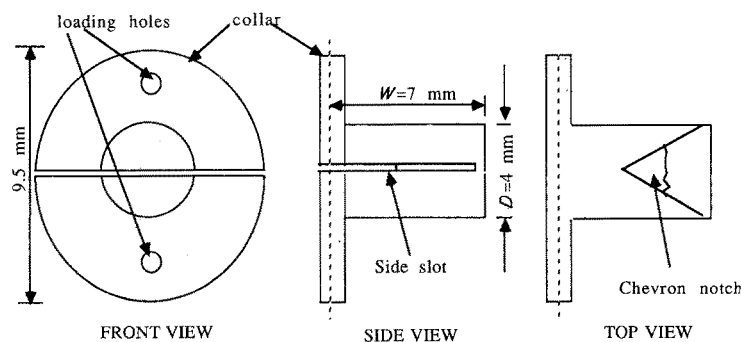

Figure 1 The geometry and the dimensions of the mini short-rod specimens.

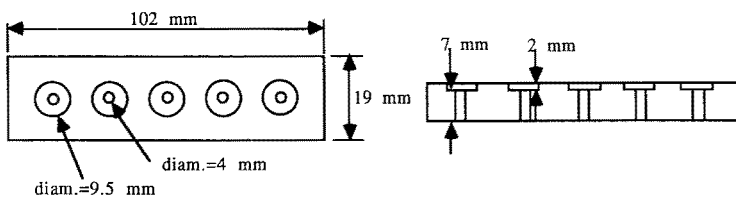

Figure 2 PTFE mould for fabrication mini short-rod bone cement specimens.

second for 1 min using a circular mixing pattern. The mixture was immediately poured into disposable plastic syringes (Monoject) with care being taken to avoid the entrapment of large air bubbles. For the CHM specimens the cement mixture was immediately injected into PTFE moulds (Fig. 2). For the CFG specimens, the loaded syringes were placed in a centrifuge (International Clinical Centrifuge model CL) and spun for a total of 1 min reaching approximately 3000 r.p.m. after which the cement mixture was injected into the moulds.

Pressure was applied during curing of the bone cement specimens in the moulds via glass slides clamped at the top and bottom surfaces of the moulds. The specimens were left to cure for 15 min in air at approximately $28 \pm 2^\circ\text{C}$. After removal from the moulds, the loading holes were drilled through the collar and the slot of the chevron notch was cut in the body of the specimen. The slot was obtained using two coplanar passes of a diamond impregnated wafering blade, turning the specimen through 60° between the two passes [39].

The Simplex-P and Zimmer LVC specimens (UHM, CHM and CFG) were divided into three subgroups. One subgroup of specimens was placed in an incubator at 37°C for 3 d in air (control specimens), and two subgroups were placed in distilled water and aged in the incubator, one group for 7 d and the other for 60 d (distilled water aged specimens). All specimens were tested at least 7 d after moulding.

2.2. Fracture toughness testing and analysis

The testing and analysis of miniature short-rod specimens deforming in a nonlinear elastic-plastic manner has been described elsewhere [39]. Briefly, the specimens were loaded in an Instron universal testing machine (model TT-CM, Instron Corp., Canton, Massachusetts) at room temperature ($25 \pm 2^\circ\text{C}$), at a cross-head speed of 0.05 cm min^{-1} . Measurements of load against slot opening are required to determine the plasticity factor, p . A non-contacting laser telemetric system (model 121, Zygo Corp., Middlefield, Connecticut) was used for monitoring the slot opening during testing. Both the Instron load cell amplifier and the laser telemetric system were interfaced with an Apple IIe computer, allowing load-slot opening data to be collected and stored. Three load-unload cycles were performed for each specimen prior to loading the specimen to complete fracture.

Measurements of necessary specimen dimensions for the calculation of K_{IC} were made on both halves of the fractured specimen using a Mitutoyo toolmakers microscope (model TM-201, Mitutoyo Corp., Tokyo, Japan) with digital micrometer readouts precise to 0.001 mm.

Hysteresis and nonlinear load-displacement behav-

our occurred upon loading and unloading most of the specimens. Following the procedures described elsewhere [39], the plasticity factor, p , equal to $\Delta X_0/\Delta X$ (see Fig. 3) was determined. Because three load-unload cycles were performed, two p values were determined for each test and the average value was used for the calculation of K_{IC} .

The value of P_c was obtained using the construction shown in Fig. 3. The line having a slope equal to $1/2.2$ times the slope of the initial portion of the first load curve was determined by interpolation. The intersection point between the load-slot opening width curve and this line gives the value of P_c . After determination of p and P_c , K_{IC} of the test material was calculated using the equation

$$K_{IC} = \frac{P_c}{DW^{1/2}} Y_m^* \left(\frac{1+p}{1-p} \right)^{1/2} \quad (1)$$

2.3. Porosity content determination

Two specimens (four halves) having the highest and the lowest K_{IC} values were selected from each specimen subgroup for porosity determination. The 36 specimens that were selected were divided into six groups: Simplex-P UHM, CHM or CFG cement specimens, and Zimmer LVC UHM, CHM or CFG cement specimens. The two broken halves of the selected bone cement specimens were embedded in dental stone with their fracture surfaces facing up. These surfaces were ground flat using 320 grit silicon carbide paper and polished with Linde B polishing powder ($0.5\mu\text{m}$), with as little material as possible being removed. The per cent porosity was determined on a plane as close to the fracture surface as possible in order to determine the effect of porosity on fracture toughness. To provide contrast between the pores and the bulk material, a mixture of Vaseline petroleum jelly and carbon powder was smeared on the polished surface and then wiped off lightly, trapping the black

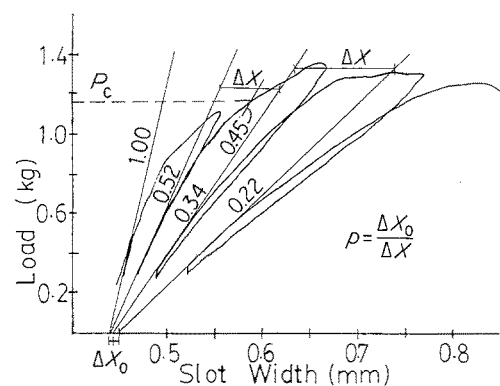

Figure 3 Typical load-displacement curve from a short-rod elastic-plastic fracture toughness test showing the method of p and P_c determination.

TABLE I Mini short-rod experimental K_{IC} results (standard deviation). n = number of specimens.

| Treatment | Simplex-P | | | Zimmer LVC | | |
|-------------------|---------------------------------|--------------------------------|--------------------------------|--------------------------------|--------------------------------|--------------------------------|
| | UHM (MPa m ^{1/2}) | CHM (MPa m ^{1/2}) | CFG (MPa m ^{1/2}) | UHM (MPa m ^{1/2}) | CHM (MPa m ^{1/2}) | CFG (MPa m ^{1/2}) |
| Control | 1.26 (0.24) $n = 7$ | 1.01 (0.07) $n = 11$ | 1.03 (0.13) $n = 11$ | 0.98 (0.11) $n = 5$ | 1.00 (0.06) $n = 13$ | 1.03 (0.06) $n = 10$ |
| 7 d aged | 1.20 (0.09) $n = 6$ | 1.04 (0.06) $n = 9$ | 1.16 (0.21) $n = 12$ | 0.90 (0.10) $n = 8$ | 1.03 (0.09) $n = 10$ | 1.05 (0.16) $n = 12$ |
| 60 d aged | 1.18 (0.13) $n = 7$ | 1.24 (0.14) $n = 8$ | 1.32 (0.14) $n = 12$ | 0.84 (0.05) $n = 6$ | 1.05 (0.10) $n = 11$ | 0.98 (0.11) $n = 11$ |
| Literature values | 0.88 – 1.6 MPa m ^{1/2} | | | | | |

mixture in the pores. Each specimen was examined under a low-power microscope to ensure complete filling of the pores.

The porosity content of the bone cement specimens was determined using an image analysis system (Perceptive Systems Inc., PSI) consisting of a video camera connected to a PDP-11/70 computer running PSI softwares. The specimen surfaces were viewed using a zoom lens on the video camera. These video images were digitized (1842 pixels) and stored on the computer disk. When all of the specimens had been digitized in a standard manner with reflected light, the images were analysed for number and area of pores (black dots on the image). The total area of the black dots was divided by the total area of the image to calculate the areal fraction of pores in each cement specimen half.

2.4. Fractography

A representative sample (one with approximately average K_{IC}) from each specimen subgroup was chosen for examination of its fracture surface by scanning electron microscopy (SEM, International Scientific Instruments model ISI-60). The selected specimen was coated with approximately 18 nm gold-palladium alloy and viewed using SEM with 10 K eV beam energy. Micrographs were taken at various magnifications on selected areas of each specimen fracture surface.

3. Results

3.1. Fracture toughness of bone cements

Average K_{IC} values and standard deviations of each specimen subgroup are listed in Table I. The smaller sample size for the UHM specimens was due to the large number of transverse fractures – fracture of the specimens perpendicular to the machined slot – that occurred, thereby rendering the test result invalid. The average plasticity correction factors, $[(1 + p)/(1 - p)]^{1/2}$, are listed in Table II. The plasticity correction factor for most specimens subgroups is greater than unity, indicating that most of the specimens had undergone some plastic deformation during the test.

Analysis of variance (for combinations of three specimen subgroups) and student t -test (for combinations of two specimen subgroups) were performed on selected combinations of specimen subgroups to determine the effect of various treatments on fracture toughness and plasticity of bone cements. Specimen combinations were compared on the basis of different ageing treatments (control, in distilled water for 7 and 60 d), material preparation methods (UHM, CHM, and CFG), and materials (Simplex-P and Zimmer LVC). Results of the analysis are shown in Tables III and IV.

Specimen combinations that were significantly different as indicated by analysis of variance were further tested using the Tukey method of the modified t -test to ascertain which pairs of the three specimen subgroups were significantly different. Results of the Tukey test are shown in Tables V and VI. Differences in the mean and the variance of the specimen subgroup were considered significant at a 95% confidence level ($p < 0.05$).

The statistical analysis of the experimental K_{IC} results indicated the following points.

(1) While K_{IC} of the UHM Simplex-P cement was not changed by the ageing treatments, that of the CHM and CFG Simplex-P bone cements was changed. K_{IC} of the CHM specimens remained constant after 7 d ageing in distilled water and increased between 7 and 60 d. K_{IC} of the 60 d aged CFG specimens was higher than the control, but not higher than the 7 d aged CFG specimens.

(2) Fracture toughness of all Zimmer LVC specimens was not affected by the different ageing treatments.

(3) UHM Simplex-P control specimens exhibited significantly higher K_{IC} values than both the CHM and CFG control specimens. This difference disappeared when the specimens were aged for 7 or 60 d in distilled water. There was no difference between the CHM and the CFG specimens with any ageing treatment.

(4) Both the CHM and the CFG Zimmer LVC specimens gave higher K_{IC} than the UHM specimens

TABLE II Plasticity correction factor (standard deviation) from mini short-rod EP fracture toughness test

| Treatment | Simplex-P | | | Zimmer LVC | | |
|-----------|--------------------------------|--------------------------------|--------------------------------|--------------------------------|--------------------------------|--------------------------------|
| | UHM (MPa m ^{1/2}) | CHM (MPa m ^{1/2}) | CFG (MPa m ^{1/2}) | UHM (MPa m ^{1/2}) | CHM (MPa m ^{1/2}) | CFG (MPa m ^{1/2}) |
| Control | 1.30 (0.26) | 1.00 (0.05) | 1.01 (0.04) | 1.11 (0.07) | 1.01 (0.03) | 1.03 (0.04) |
| 7 d aged | 1.08 (0.10) | 1.04 (0.05) | 1.03 (0.05) | 1.20 (0.13) | 1.09 (0.07) | 1.06 (0.05) |
| 60 d aged | 1.05 (0.04) | 1.03 (0.04) | 1.07 (0.03) | 1.06 (0.05) | 1.11 (0.07) | 1.07 (0.04) |

TABLE III Statistical analysis of the mini short-rod experimental K_{IC} results (ANOVA or t -test)

| Specimen groups | Treatment compared | Stat. test result | P |
|-----------------|---|-------------------|----------|
| S-UHM | Ageing in water (control versus 7 d aged versus 60 d aged) | No Diff. * | > 0.2 |
| S-CHM | | Sig. Diff. * | < 0.005 |
| S-CFG | | Sig. Diff. * | < 0.005 |
| Z-UHM | | No Diff. * | > 0.05 |
| Z-CHM | | No Diff. * | > 0.25 |
| Z-CFG | | No Diff. * | > 0.25 |
| S control | Material preparation (UHM versus CHM versus CFG) | Sig. Diff. * | < 0.005 |
| S-7 d aged | | No Diff. * | > 0.1 |
| S-60 d aged | | No Diff. * | > 0.05 |
| Z control | | No Diff. * | > 0.25 |
| Z-7 d aged | | Sig. Diff. * | < 0.05 |
| Z-60 d aged | | Sig. Diff. * | < 0.005 |
| UHM control | Materials (Simplex-P versus Zimmer LVC) | No Diff. † | > 0.01 |
| UHM 7 d aged | | Sig. Diff. † | < 0.0005 |
| UHM 60 d aged | | Sig. Diff. † | < 0.0005 |
| CHM control | | No Diff. † | > 0.4 |
| CHM 7 d aged | | No Diff. † | > 0.1 |
| CHM 60 d aged | | Sig. Diff. † | < 0.005 |
| CFG control | | No Diff. † | > 0.4 |
| CFG 7 d aged | | No Diff. † | > 0.05 |
| CFG 60 d aged | | Sig. Diff. † | < 0.0005 |

S = Simplex-P.

Z = Zimmer LVC.

*ANOVA.

† t -test.

after storage in distilled water for 60 d, whereas after 7 d in water only CFG specimens were more fracture resistant than UHM specimens. However, there was no difference in fracture toughness between the CHM and CFG specimens. There were no significant differences between the three subgroups of control specimens.

(5) Comparison of K_{IC} for Simplex-P and Zimmer LVC cements showed that when prepared using the UHM method, the two cements exhibited similar K_{IC} values if they were not aged in distilled water. Simplex-

P, however, showed higher K_{IC} after ageing in water for 7 and 60 d.

No differences existed between the two cements prepared using CHM and CFG if they were either not aged in water or aged only for 7 d. Simplex-P bone cement, however, showed higher K_{IC} after storage for 60 d in distilled water.

3.2. Porosity content

Results of the image analysis to determine the areal fraction of porosity of the bone cement specimen

TABLE IV Statistical analysis of the mini short-rod experimental plasticity correction factors (ANOVA or t -test)

| Specimen groups | Treatment compared | Stat. test result | P |
|-----------------|---|-------------------|----------|
| S-UHM | Ageing in water (control versus 7 d aged versus 60 d aged) | Sig. Diff. * | < 0.025 |
| S-CHM | | No Diff. * | > 0.1 |
| S-CFG | | Sig. Diff. * | < 0.01 |
| Z-UHM | | Sig. Diff. * | < 0.05 |
| Z-CHM | | Sig. Diff. * | < 0.005 |
| Z-CFG | | No Diff. * | > 0.1 |
| S control | Material preparation (UHM versus CHM versus CFG) | Sig. Diff. * | < 0.005 |
| S-7 d aged | | No Diff. * | > 0.25 |
| S-60 d aged | | No Diff. * | > 0.05 |
| Z control | | Sig. Diff. * | < 0.005 |
| Z-7 d aged | | Sig. Diff. * | < 0.005 |
| Z-60 d aged | | No Diff. * | > 0.1 |
| UHM control | Materials (Simplex-P versus Zimmer LVC) | No Diff. † | > 0.05 |
| UHM 7 d aged | | Sig. Diff. † | < 0.0005 |
| UHM 60 d aged | | No Diff. † | > 0.1 |
| CHM control | | No Diff. † | > 0.375 |
| CHM 7 d aged | | Sig. Diff. † | < 0.05 |
| CHM 60 d aged | | Sig. Diff. † | < 0.01 |
| CFG control | | No Diff. † | > 0.1 |
| CFG 7 d aged | | No Diff. † | > 0.05 |
| CFG 60 d aged | | No Diff. † | > 0.4 |

*ANOVA.

† t -test.

TABLE V Statistical analysis of the mini short-rod experimental K_{IC} results (Tukey test)

| Specimen groups | Treatment compared | Tukey test result | <i>P</i> |
|-----------------|--------------------------|-------------------|----------|
| S-CHM | Control versus 7 d aged | No. diff. | > 0.05 |
| | Control versus 60 d aged | Sig. diff. | < 0.05 |
| | 7 d versus 60 d aged | Sig. diff. | < 0.05 |
| S-CFG | Control versus 7 d aged | No. diff. | > 0.05 |
| | Control versus 60 d aged | Sig. diff. | < 0.05 |
| | 7 d versus 60 d aged | No. diff. | > 0.05 |
| S control | UHM versus CHM | Sig. diff. | < 0.05 |
| | UHM versus CFG | Sig. diff. | < 0.05 |
| | CHM versus CFG | No. diff. | > 0.05 |
| Z 7 d aged | UHM versus CHM | No. diff. | > 0.05 |
| | UHM versus CFG | Sig. diff. | < 0.05 |
| | CHM versus CFG | No. diff. | > 0.05 |
| Z 60 d aged | UHM versus CHM | Sig. diff. | < 0.05 |
| | UHM versus CFG | Sig. diff. | < 0.05 |
| | CHM versus CFG | No. diff. | > 0.05 |

groups are shown in Table VII. The table also shows the results of statistical tests indicating significant differences, if any, of porosity between specimen groups.

Analysis of variance indicated that there were significant differences in porosity between the bone cement specimens prepared using the three different methods for both the Simplex-P ($p < 0.0001$) and the Zimmer LVC ($p < 0.025$) bone cement. Tukey or Bonferroni tests were performed after analysis of variance to verify the specific combination of specimen groups that were significantly different at the 95% confidence level.

Test results showed that Simplex-P cement prepared using the UHM method had significantly higher porosity than that prepared using CHM or CFG method. No difference in porosity was observed between Simplex-P CHM and CFG specimens. For Zimmer LVC cement, there was no difference between

the UHM and the CHM specimens in terms of porosity. CFG Zimmer LVC specimens, however, showed significantly lower porosity content than both the CHM and UHM specimens.

Plots of porosity against K_{IC} for Simplex-P and Zimmer LVC (Fig. 4) showed no recognizable trend.

3.3. Fractography

Typical fracture surfaces of Simplex-P and Zimmer LVC specimens are shown in Figs 5 and 6, respectively. Fracture topography of the UHM specimens was distinct, at low magnification, from the other two subgroups due to its "hilly" appearance. At medium magnifications (approximately 500 times), however, the fracture surfaces were indistinguishable (Figs 7 and 8).

Recognizable features on the surfaces of Simplex-P specimens included parabolic markings and crazed material (white areas [45]) around fractured polymer

TABLE VI Statistical analysis of the mini short-rod experimental plasticity correction factors (Tukey test)

| Specimen groups | Treatment compared | Tukey test result | <i>P</i> |
|-----------------|--------------------------|-------------------|----------|
| S-UHM | Control versus 7 d aged | No. diff. | > 0.05 |
| | Control versus 60 d aged | Sig. diff. | < 0.05 |
| | 7 d versus 60 d aged | No. diff. | > 0.05 |
| S-CFG | Control versus 7 d aged | No. diff. | > 0.05 |
| | Control versus 60 d aged | Sig. diff. | < 0.05 |
| | 7 d versus 60 d aged | Sig. diff. | < 0.05 |
| Z-UHM | Control versus 7 d aged | No. diff. | > 0.05 |
| | Control versus 60 d aged | No. diff. | > 0.05 |
| | 7 d versus 60 d aged | Sig. diff. | < 0.05 |
| Z-CHM | Control versus 7 d aged | Sig. diff. | < 0.05 |
| | Control versus 60 d aged | Sig. diff. | < 0.05 |
| | 7 d versus 60 d aged | No. diff. | > 0.05 |
| S control | UHM versus CHM | Sig. diff. | < 0.05 |
| | UHM versus CFG | Sig. diff. | < 0.05 |
| | CHM versus CFG | No. diff. | > 0.05 |
| Z control | UHM versus CHM | Sig. diff. | < 0.05 |
| | UHM versus CFG | Sig. diff. | < 0.05 |
| | CHM versus CFG | No. diff. | > 0.05 |
| Z 7 d aged | UHM versus CHM | Sig. diff. | < 0.05 |
| | UHM versus CFG | Sig. diff. | < 0.05 |
| | CHM versus CFG | No. diff. | > 0.05 |

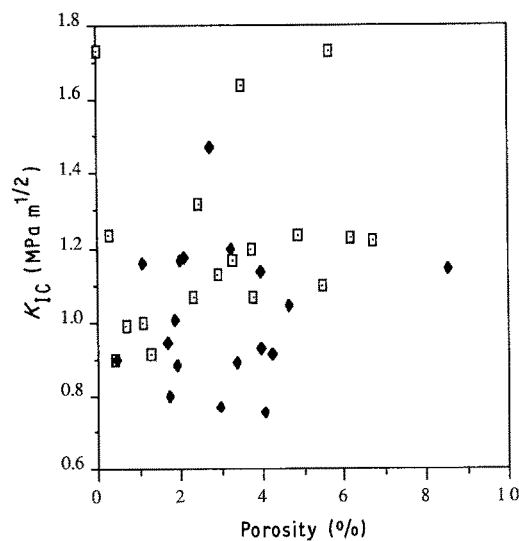

Figure 4 Fracture toughness-positivity curve of (□) Simplex-P and (◆) Zimmer LVC bone cements.

particles as indicated in Fig. 9. The topography of the Simplex-P bone cement fracture surface was relatively flat at medium magnification because of the predominance of transgranular fracture.

The scanning electron fractographs of Zimmer LVC samples were quite distinct from that of Simplex-P cement mainly due to the presence of barium sulphate particles. At 500 times magnification, the fracture surface of Zimmer LVC cement appeared to be dotted with colonies of white specks and fibrous structures obscuring the general topography under-

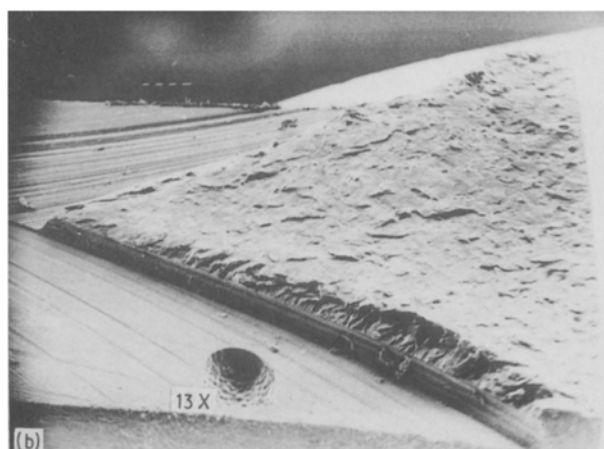
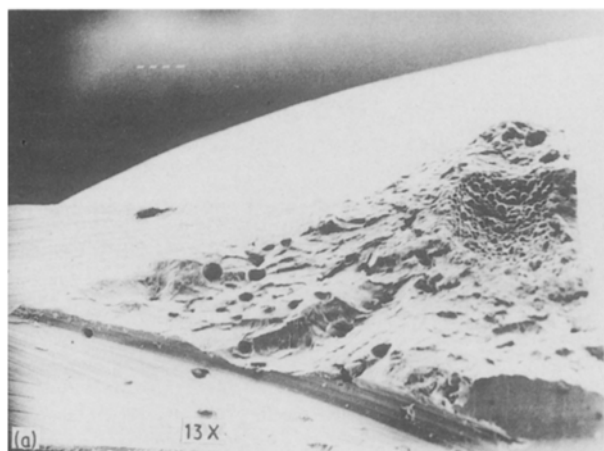

TABLE VII Per cent areal porosity content of bone cements (standard deviation). Number of specimens per subgroup = 12.

| Preparation method | Per cent porosity | |
|--------------------|-------------------|-------------|
| | Simplex-P | Zimmer LVC |
| UHM | 5.2% (1.7%) | 3.9% (1.1%) |
| CHM | 2.3% (1.6%) | 3.6% (2.9%) |
| CFG | 1.6% (1.7%) | 1.6% (1.1%) |

(---) No significant difference ($p > 0.05$).

(—) Significant difference ($p < 0.05$).

neath (Fig. 8). At high magnification, however, individual radiopaque particles could be resolved. The inclusions were usually situated in the centre of a microvoid with white borders around the perimeter (see Fig. 10) indicating crazing. The general topography of the Zimmer LVC fracture surface was rougher than that of the Simplex-P cement with a large number of cusps and cleavage steps evident as seen in the micrograph shown in Fig. 8.

Fracture of the Simplex-P bone cement powder phase appeared strictly transgranular, that is, the crack ran through the powder particles thereby forming a relatively flat fracture surface. Occasional intergranular fractures were observed (Fig. 11) on the fracture surfaces of Zimmer LVC cement, although Zimmer LVC powders also predominantly fractured transgranularly.

4. Discussion

4.1. Fracture toughness of bone cements

4.1.1. Effect of porosity

In a surgical construct consisting of prosthesis, bone cement and bone, it is believed that the "weak-link" is the bone cement [23, 27]. Clinical studies have shown that loosening of femoral stems have been associated with fracturing of bone cement [4, 5, 7, 13, 14, 23]. Finite element analysis and *in vitro* strain gauge experiments have shown that the stresses applied to the cement mantle surrounding a total hip replacement are close to or exceed the fatigue strength of the

Figure 5 Low magnification SEM fractographs of Simplex-P (a) UHM, (b) CHM, and (c) CFG specimens. Note that the fracture surface of the UHM specimen is much less planar than the other two.

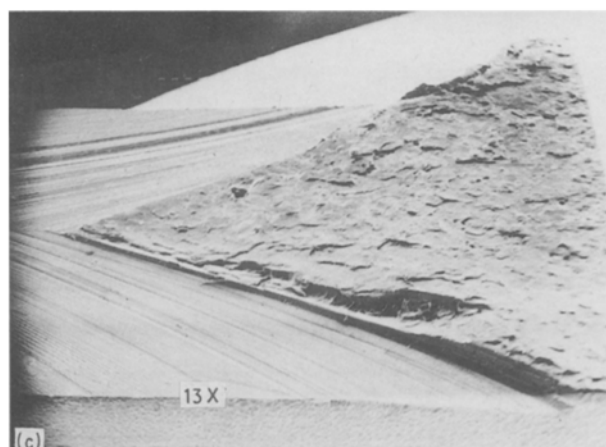

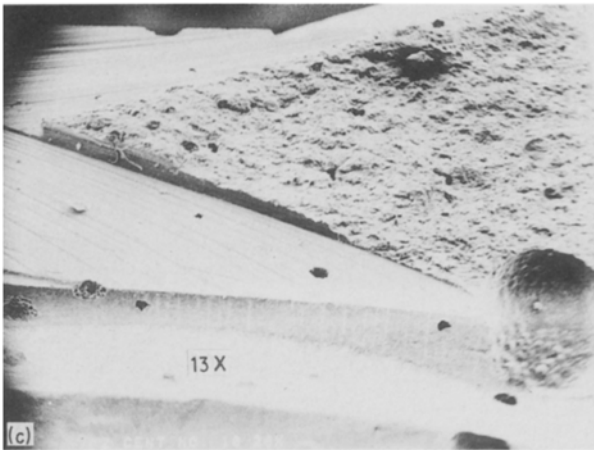
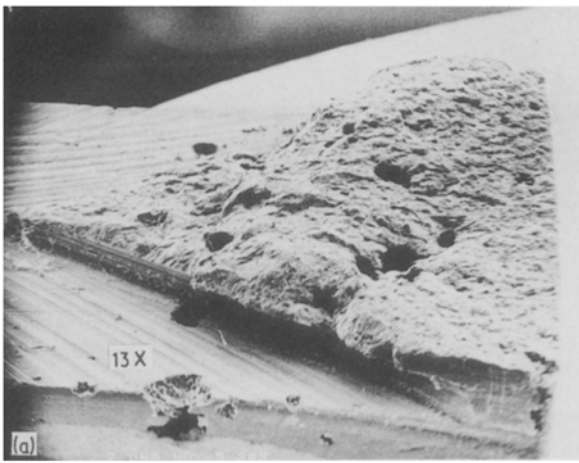

Figure 6 Low magnification SEM fractographs of Zimmer LVC (a) UHM, (b) CHM, and (c) CFG specimens. Note that the fracture surface of the UHM specimen is much less planar than the other two.

material [23]. Many researchers attribute the relative weakness of bone cement, as compared to commercial forms of PMMA, to its porous nature. In a study by Eyerer and Jin [34], factors associated with the handling of bone cement with respect to the resulting density and mechanical properties of the bone cement were examined. They proposed the use of an optimum cement mixing technique featuring a slow mixing rate and a short mixing time to increase both the density and mechanical properties of the resulting bone cement. Lee *et al.* [43] also demonstrated that the ultimate compressive strength (UCS) of bone cements made from dough beaten at 4.33 Hz was 10% less than the UCS of cement mixed at 1 Hz. It was thought that the effect of mixing frequency on UCS was related to the porosity of the subsequently cured cement. Bayne *et al.* [15] reported a 10% difference in compressive yield strength with two groups of bone cement specimens of widely varying porosity. Hand mixing at 150 c.p.m. and curing at ambient pressure resulted in a large number of air bubbles while curing under an applied pressure of 27.5 MPa resulted in no visible air bubbles and increased static strengths.

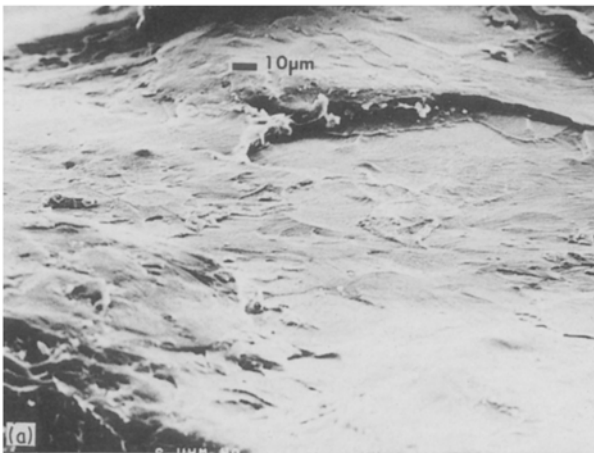
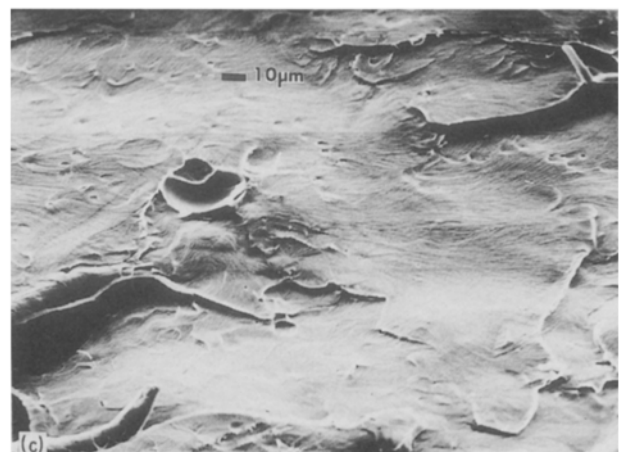
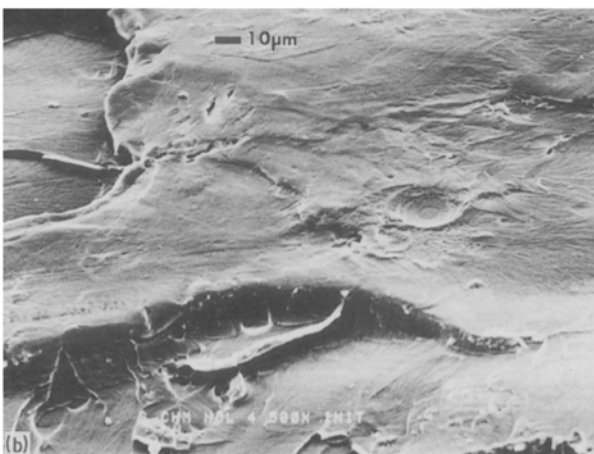

Figure 7 Medium magnification SEM fractographs of Simplex-P (a) UHM, (b) CHM and (c) CFG specimens. Note that the fracture surfaces are indistinguishable at this magnification.



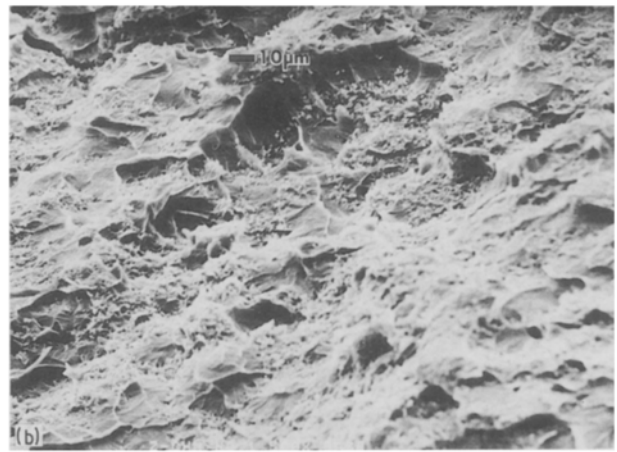
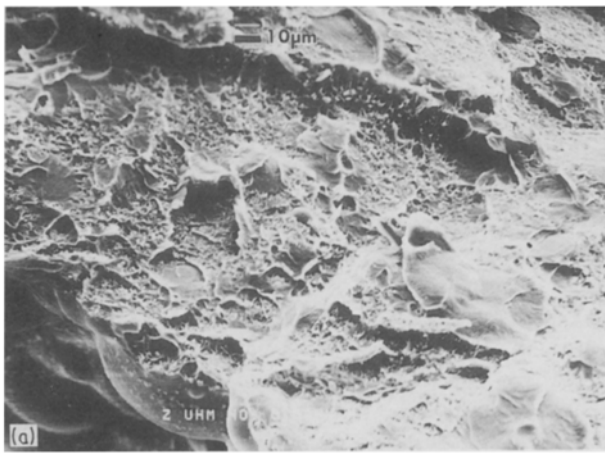

Figure 8 Medium magnification SEM fractographs of Zimmer LVC (a) UHM, (b) CHM and (c) CFG specimens. Note that at this magnification the three fracture surfaces are indistinguishable.

De Wijn *et al.* [19] confirmed the adverse effect of porosity on mechanical properties of bone cement. Results of flexural and impact tests of porous and nonporous (cured under 2 atm pressure) bone cement specimens indicated a 50% reduction in the impact and flexural strength due to porosity. Beaumont and Young [46] reported a 46% increase in K_{IC} (1.68 compared to 1.15 MPa m^{1/2}) of Simplex-P bone cement cured under a pressure of 0.71 rather than 0.07 MPa. The researchers believed that the increased fracture toughness was due to the decrease of void content in the cement cured under higher pressure.

Unfortunately, the application of high pressure

during curing of bone cement to reduce its porosity is not practical during clinical use. Clinically practical methods of porosity reduction including centrifugation, mixing under vacuum, and ultrasonic vibration have been evaluated by several researchers [16, 17, 22–30]. While these methods have proved effective in reducing porosity [16, 17, 20, 22, 23–25], improvements in mechanical properties have not necessarily followed.

Burke *et al.* showed in a series of studies [23, 27–30] that centrifugation of simplex-P bone cement for 30 sec at 2500 to 4000 r.p.m. after hand-mixing (45 sec at 120 c.p.m.) resulted in an increase in the unnotched fatigue strength (by 136%), and the ultimate tensile strength (by 25%). Reports by Noble *et al.* [24, 27] supported the findings that centrifugation of hand-mixed cements resulted in improved strengths. Young's modulus of bone cement has been reported as being decreased (Zimmer LVC) [32] or remaining constant (Simplex-P, Zimmer Regular) [32, 38] after centrifugation.

Reduced porosity and similar improvements in mechanical properties have also been reported for cements prepared by controlled mixing under partial vacuum (60 c.p.m. for 1 min at 550 mm Hg) [24, 25,

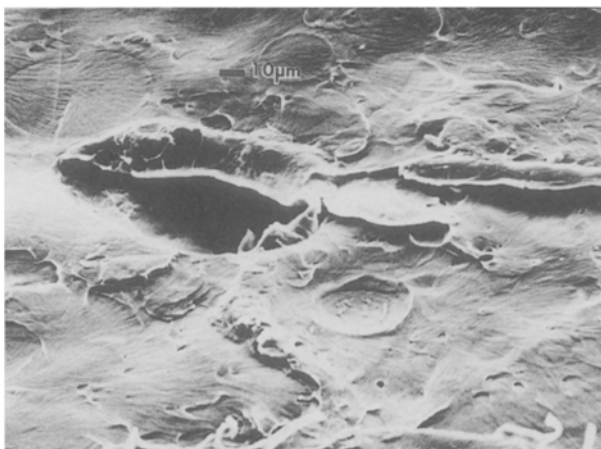

Figure 9 Fracture surface of a Simplex-P specimen showing parabolic markings and evidence of crazed material surrounding fractured polymer particles.

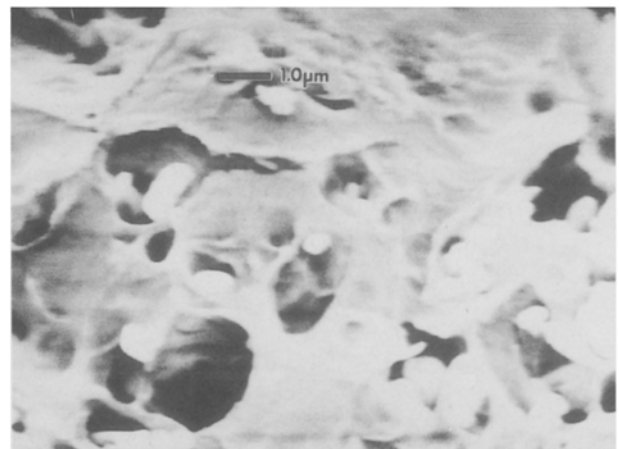

Figure 10 High magnification micrograph of Zimmer LVC bone cement fracture surface. BaSO₄ particles are situated in microvoids with white perimeters indicating the presence of craze.

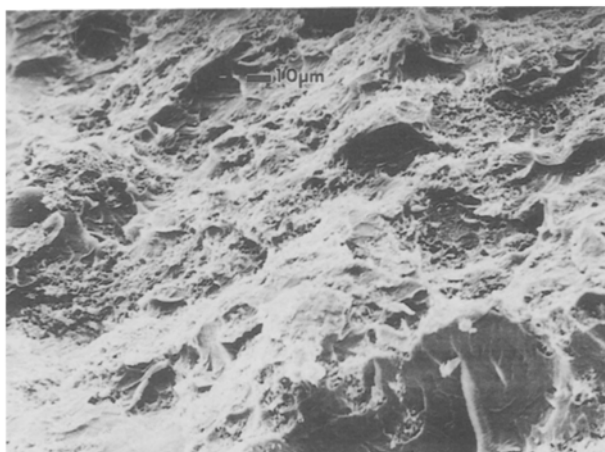

Figure 11 Occasional intergranular fracture can be seen in Zimmer LVC cement.

47]. Wixson *et al.* [25] reported a ten-fold increase in fatigue life for cements so-treated.

Hand-mixing followed by ultrasonic vibration was reported by Saha and Warman [26] to improve the compressive strength of Simplex-P bone cement. Both the ultimate compressive strength and the energy adsorption capacity of the vibrated cement were found to have increased significantly (7% and 17%, respectively) as compared to the hand-mixed control specimens.

In contrast to these reported improvements in mechanical properties due to centrifugation, Rimnac *et al.* [22] reported no significant improvement in the fracture toughness or the resistance to fatigue-crack propagation for cements formed using centrifugation (4000 r.p.m. for 30 sec). The authors suggested that this insensitivity to porosity was due to the pre-crack in the compact tension test specimens producing a more severe stress concentration than that associated with any intrinsic pores.

Results of the present work also indicate centrifugation following slow careful hand-mixing of Simplex-P bone cement does not result in improved fracture toughness compared with non-centrifuged cement. This is not surprising because no significant difference in porosity was found between the CHM and CFG subgroups (Table VII).

Fracture toughness of the Simplex-P UHM specimens, however, was significantly higher than the specimens prepared by the other two methods. This difference disappeared with ageing in water. The higher K_{IC} for the UHM specimens was possibly related to an effect of residual monomer acting as a plasticizer in this subgroup. The UHM specimens were formed using room-temperature monomer while the monomer was precooled for the CHM and CFG specimens. Stubbs *et al.* [48] showed that much greater amounts of monomer were released during polymerization of precooled bone cement. Thus, a greater amount of unreacted monomer would have been present in the UHM specimens and it would have acted as a plasticizer. This could explain the higher fracture toughness of the UHM unaged bone cement. For the water aged specimens, a proportionally greater amount of monomer would be expected to be released from the UHM specimens during storage in water due to its

higher initial concentration compared with CHM and CFG specimens. Therefore, the UHM specimens would experience a significant decrease in plasticity (as was observed, Table II) and possibly fracture toughness after ageing in water. Thus, it appeared that, in this case, porosity was not the dominant factor controlling fracture toughness.

Although porosity of the Zimmer LVC CFG specimens was significantly lower than that of the CHM specimens, no difference in K_{IC} was observed for this material. No difference between the UHM specimens and the other two subgroups further indicated that varying porosity (between 1.6 and 3.6%) did not significantly affect K_{IC} for the Zimmer LVC specimens that were not aged in water. Storage of the test specimens in water for up to 60 days, however, appeared to cause a decrease in fracture toughness of UHM specimens, whereas K_{IC} of CHM and CFG specimens increased. This difference in behaviour possibly was related to a difference in monomer content and varied amounts of water sorption as discussed in the next section.

Although the per cent porosity did not appear to influence K_{IC} in our studies, an effect on fracture surface appearance was observed. As seen in Fig. 5, the fracture surface of the UHM specimens was much rougher than that of the CHM or CFG specimens. This could have been due to the interaction of the propagating crack front with the larger number of pores in the UHM specimens. The result of this interaction is crack arrest and/or out-of-plane crack deflection. The consequences of this are (1) a larger fracture surface area, and (2) zones in which mode I (crack opening) loading does not apply. Both effects would result in a higher apparent K_{IC} . Thus increased porosity could cause easier crack initiation while the resulting increased fracture path rugosity could increase subcritical crack growth. Therefore fracture toughness would appear insensitive to porosity.

As indicated by the test results of Rimnac *et al.* [22] and the present study, some porosity did not appear to be detrimental to the fracture resistance of the bone cements studied. Spherical pores create minimal stress concentrations as compared to sharper irregularities and it is even possible that the ability of such pores to deflect or arrest propagating cracks is beneficial. Our results have indicated, however, that high porosity content samples, such as those prepared by UHM are adversely affected by ageing in water and, therefore, are inferior to the lower porosity specimens prepared by CHM or CFG methods.

4.1.2. Effect of ageing in water

During ageing of bone cement in water, three major factors affecting fracture toughness have been identified: (1) water sorption [48, 55], (2) leaching of monomer [48–50, 55], and (3) further polymerization [56].

Reported equilibrium water content in PMMA specimens, usually reached within 2 months of immersion in water, are in the range of 1.5 to 3% by weight [51–55].

Mechanical testing of water-saturated commercial and medical grade PMMA specimens has shown that

the inclusion of water is generally detrimental to ultimate strength and modulus of elasticity [37, 38, 43, 49–51, 53, 57–61]. A 3.5% decrease in bending strength was observed by Rostoker *et al.* [60] after *in vivo* ageing for 24 mon.

Fatigue life of PMMA has also been found to be adversely affected by water absorption. Water sorption of 1 wt % has been shown to cause a ten-fold decrease in fatigue life of low and high molecular PMMA [53]. Most researchers have attributed the detrimental effect of water on strength of PMMA to its ability to promote earlier craze development, faster craze growth and more rapid craze breakdown.

Some increases in the strength of bone cement and dental acrylic specimens aged for short periods in water have been reported, however, [37, 38, 43, 60, 61]. Reports indicated that maximum compressive [38, 43], and bending strengths [37, 61] of Simplex-P bone cement were reached after a 1 to 2 wk period of water ageing. Rostoker *et al.* [60] reported increased bending strength of implanted Simplex-P bone cement between 6 and 12 mon. Further polymerization and leaching out of monomers, which act as plasticizers, were thought to be the cause of this initial rise in strength.

Because both water and monomer plasticize PMMA, fracture toughness of the material after storage in water depends upon the relative amounts of water and monomer present in the specimen. Haas *et al.* [41] reported that on storage of PMMA-based bone cement in air the residual monomer concentration in the cured specimens fell slowly to 2.4% after 215 d, whereas if the sample was stored in water at 37°C, the monomer content was reduced to 1.4% in approximately 137 d. The larger drop of residual monomer for water-stored specimens could be due to either a leaching out effect [41, 58] or further polymerization [56]. A decrease in monomer content would result in a decrease in the number of inherent flaws within the material [58]. It has been shown that at high water contents, i.e. greater than 1%, water molecules cluster in the neighbourhood of polar groups in the polymer chain and cause more rapid craze breakdown as these clusters act as stress-concentrating flaws [51]. Thus, ageing in water can result in either higher fracture toughness (because of the increased amount of plastic deformation resulting from absorbed water acting as a plasticizer) or lower K_{IC} (because of water molecule clusters acting as stress concentrators). The behaviour of the specimens therefore not only varies with the relative amount of water and monomer within the specimen, but also with the absolute values of water and monomer contents.

No changes in K_{IC} were observed for Perspex specimens aged in water for 1 and 6 mon [49, 50, 62]. A 7% increase in fracture toughness of dental PMMA stored in various solutions for 1 mon at room temperature was reported by Hargreaves [63], whereas Hill *et al.* [49, 50] reported an average increase of 10 to 17% in K_{IC} for five dental acrylics aged for 1 mon in water.

Testing as-processed acrylic specimens in aqueous solution [44, 46, 49, 63, 64] or bovine serum solution [44] showed up to a 100% increase in K_{IC} [65] and a four-fold increase in fracture energy [62]. These results

were consistent with the premise that water acts as a plasticizer causing crack-tip blunting, thereby dissipating some strain energy by plastic deformation.

Our experimental results suggested that Simplex-P specimens prepared using CHM and CFG methods were affected by ageing in water. K_{IC} values increased by 23 and 28%, respectively, after storage in distilled water for 60 d at 37°C. The plasticity correction factor of CHM specimens did not change with ageing, suggesting that the increased plasticizing effect due to absorbed water and the reduced plasticity due to decreased residual monomer cancelled each other. The increased fracture toughness in this subgroup, therefore, can be attributed to further polymerization and/or decreased microfaults due to leaching out of monomers. The plasticity correction for the CFG specimens, however, increased by 6% after ageing for 60 d although there was no significant difference in porosity between CHM and CFG specimens. This increase in plasticity was unexpected and its cause remains unknown. The higher rise in K_{IC} of the CFG as compared to the CHM specimens after ageing can be explained by this increase in plasticity.

Plasticity of the UHM specimens decreased by 20% after storage in water for 60 d although its fracture toughness remained constant. Two factors may have contributed to this decrease in plasticity. First, the higher porosity would have facilitated water transport into and monomer leaching out of the specimens. The net effect would be a reduction in plasticity. Second, the larger decrease in monomer content during storage in water due to its high initial content as discussed previously may have contributed to the decrease in plasticity of the UHM specimens. Although a corresponding decrease in K_{IC} was not observed with ageing of UHM specimens, a general trend toward lower K_{IC} values was seen (Table I) which was masked by the large standard deviation in the test results.

Fracture toughness of all the Zimmer LVC specimens was not significantly altered by the water ageing treatment. Plasticity of the CHM specimens increased by 10% whereas that of the CFG specimens remained constant. The porosity content of the two groups of specimens was significantly different, and, therefore, we may conclude that the different response to the ageing treatment was due to its porosity difference. Plasticity of the UHM specimens decreased by 14% over the 60 d ageing period with a corresponding trend of decreasing fracture toughness similar to the Simplex-P specimens.

These results give support to the statement that different responses to ageing for different preparation methods were due to the resulting different porosity levels. Thus, if we assume that an equilibrium water content in the mini short-rod specimens has been reached within 60 days (a fair assumption in light of reported water sorption results on commercial PMMA [51–54]), then an optimum porosity content, in terms of maximizing K_{IC} and plasticity of the material may be defined for these two bone cements based on our experimental results. Optimum porosity for Simplex-P cement appeared to be less than 1.6%, whereas a porosity level between 1.6 and 3.6% was

best for Zimmer LVC bone cement (see Tables I, II and VII).

4.1.3. Simplex-P compared with Zimmer LVC

Several researchers have compared the mechanical properties of Simplex-P and Zimmer LVC cements and the results are sometimes contradictory. Krause and Mathis [66] tested Simplex-P and Zimmer LVC bone cements in fatigue and showed that the fatigue behaviour of Simplex-P was superior to that of LVC. Gates *et al.* [67], however, found no significant difference in the tensile or fatigue strength of the two cements. Davies *et al.* [32] tested three bone cements, including Simplex-P and Zimmer LVC, prepared both routinely and centrifuged after mixing and found that Simplex-P cement was superior in fatigue (centrifuged or hand mixed). Centrifuged LVC specimens, however, appeared stronger in tension than Simplex-P, but there was no significant difference between the ultimate tensile strength of the two cements if prepared without centrifugation. Experimental results obtained by Weber and Bargar [68] indicated that Simplex-P and Zimmer LVC bone cements were equal in compressive and tensile strength, as well as fracture toughness after 1 and 14 d curing in air. Robinson *et al.* [69] also reported that no difference existed between the compressive strength of Simplex-P and Zimmer LVC cements. Fracture toughness of Simplex-P cement, however, was found to be greater than that of LVC bone cement.

Fracture toughness tests using mini short-rod specimens performed in our laboratory showed no significant difference in K_{IC} between Simplex-P and Zimmer LVC cements prepared using either of the three methods and aged in air. Differences in K_{IC} between the two cements appeared only after storage in water for 60 d due to increased toughness of Simplex-P while that of Zimmer LVC decreased with ageing. Freitag and Cannon [44] reported higher K_{IC} for Simplex-P and Zimmer cements tested with the inclusion of $BaSO_4$ both in air and bovine serum. It is therefore unlikely that the presence of the radiopaque fillers in Zimmer LVC cement could have generated the difference in fracture toughness observed in our test, namely a lower K_{IC} for the water aged LVC cement.

4.2. Comparison of mini short-rod fracture toughness test results with literature values

K_{IC} values for Simplex-P and Zimmer Regular or LVC cements measured by various researchers range between 0.88 to 1.6 MPa m^{1/2} [22, 44, 46, 68–72] (Table I). A number of factors may have caused the large scatter in results, including differences in specimen preparation, testing conditions and test methods. Comparing our results with those obtained from the literature indicates that our measured K_{IC} values for both Simplex-P and Zimmer LVC cements are within the range of values reported by others.

It is also evident that fracture toughness of both cements determined using the short-rod EP method fell in the low end of the literature values. This lower value was expected compared to the values reported

by others who used precracks that were much less sharp than a steady-state propagating crack. The majority of the researchers [44, 68–71] utilized an SEN specimen with 45° machined notch which generally gives higher K_{IC} s. The short-rod EP fracture toughness test method using miniature specimens appears suitable for determining the fracture toughness of bone cement.

4.3. Porosity content

The two bone cements responded differently in terms of porosity and its dependence on methods of preparation. This could have been due to the different cement viscosities. Slow hand-mixing appeared to significantly reduce the void content of the more viscous Simplex-P cement possibly because of reduced air entrapment, whereas for Zimmer LVC cement, slow hand-mixing was not effective because turbulence was easily created in this more fluid mixture.

Centrifugation, however, was not as effective in removing air bubbles from Simplex-P as from Zimmer LVC bone cement. This difference could, once again, be attributed to differences in viscosity. Our centrifugation process perhaps did not supply the centrifugal force necessary to force the air bubbles to separate from the more viscous mixture, but it was sufficient for the low viscosity cement. A higher spinning rate could have been tried, but separation of the mixture into powder and liquid is always a possibility with high centrifugation rates.

4.4. Fractography

Evidence supporting the experimental result that fracture resistance of bone cements increased with the inclusion of $BaSO_4$ [44] could be found in scanning electron micrographs showing the fracture surface of Zimmer LVC bone cements. The radiopaque particles seen on the fracture surface were situated in the centre of small pits of characteristic shape as described by Lednický and Pelzbauer [45]. The white coloured perimeter around the pits suggested a ductile fracture mode in which the material was highly extended (crazed) causing lower electron scattering due to lower density (Fig. 10). This ductile fracture mode could be satisfactorily described by the secondary fracture coalescence mechanism proposed by Lednický and Pelzbauer [45].

Lednický and Pelzbauer suggested that in commercial PMMA, secondary fracture may have been initiated at microvoids. For Zimmer LVC bone cement, however, this ductile fracture mechanism appeared to have been initiated by both the inclusion of $BaSO_4$ particles and the polymer powder particles, as illustrated by the micrographs in Fig. 12. The remnants of the secondary fractures nucleated at the powder particle/matrix interface could be identified on the micrographs as cusps with white coloured borders (Figs 8 and 12). Owing to the random distribution of the polymer particles, the secondary cracks did not meet at the same level, and cleavage steps were often seen joining individual cusps.

This larger scaled secondary fracture (initiated at powder particle/matrix interface) was better identified

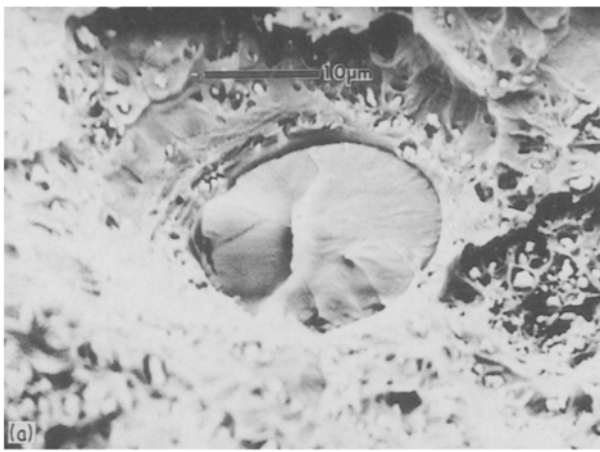

Figure 12 Fracture surface of a Zimmer LVC specimen shown in two magnifications. Note the density and the morphology of the secondary fractures in this material.

on the fracture surface of Simplex-P cement (Fig. 9) where it was not obscured by the more numerous fractures initiated at the BaSO_4 /matrix interfaces. Much less secondary cracking and ductile deformation appears to have occurred during the fracture of Simplex-P bone cement. The fracture surface was flatter than that of Zimmer LVC cement, with small cleavage steps and faint white traces marking the edges of cusps and cones. However, experimentally determined plasticity correction factors did not indicate this reduced ductile deformation. No immediately obvious reasons could account for this lack of experimental support.

5. Conclusions

1. Fracture toughness of Simplex-P and Zimmer LVC bone cements were not improved by centrifugation after slow hand-mixing. Centrifuged and slow hand-mixed specimens were more fracture resistant than specimens prepared using the UHM method after storage in distilled water at 37°C.

2. Porosity content of the cement alone, at least over the range of porosities encountered, did not appear to be the controlling factor determining K_{IC} . No correlation between fracture toughness and porosity could be found for both Simplex-P and Zimmer LVC cements.

3. The effect of storage in water at 37°C differed according to the processing and nature of the bone cement. The fracture toughness of UHM specimens decreased with ageing mainly due to a significant drop in plasticity of the material. K_{IC} of the CHM and CFG specimens generally remained constant with ageing (except for Simplex-P CFG specimens). The different behaviour of the specimen subgroups may be due to a structural difference, i.e. different amounts of porosity, or due to higher initial (before ageing) residual monomer content of the UHM specimens.

4. An optimum value of porosity content could be defined for each bone cement in terms of maximizing fracture toughness and plasticity after periods of ageing in water. The optimum void content for Simplex-P bone cement appeared to be less than 1.6% whereas it was between 1.6 and 3.6% for Zimmer LVC cement.

5. Simplex-P bone cement had superior fracture

toughness compared to Zimmer LVC cement after storage in water for 60 d, although no difference was detected when the specimens were tested without ageing.

References

1. K. J. BUNDY and R. W. PENN, *J. Biomed. Mater. Res.* **21** (1987) 773.
2. M. T. MANLEY, L. S. STERN and J. GURTOWSKI, *ibid.* **19** (1985) 563.
3. R. D. BECKENBAUGH and D. M. ILSTRUP, *J. B. Jt. Surg.* **A60** (1978) 306.
4. T. A. GRUEN, G. M. McNEICE and H. C. AMSTUTZ, *Clin. Orthop. Relat. Res.* **141** (1979) 17.
5. M. MARTENS, E. AERNOUDT, P. DEMEESTER, P. DUCHEYNE, J. C. MULIER, R. DELANGH and P. KESTELIJN, *Acta Orthop. Scand.* **45** (1974) 693.
6. E. A. SALVATI, V. C. IM, P. AGLIETI and P. D. WILSON Jr, *Clin Orthop.* **121** (1976) 74.
7. F. A. WEBER and J. CHARNLEY, *J. B. Jt. Surg.* **B57** (1975) 297.
8. R. D. CROWINSHIELD and J. R. TOLBERT, *J. Biomed. Mater. Res.* **17** (1983) 819.
9. S. RAAB, A. M. AHMED and J. W. PROVAN, *ibid.* **15** (1981) 159.
10. R. M. STAUTTER, *J. B. Jt. Surg.* **A64** (1982) 983.
11. J. F. PARK, A. F. VON RECUM and G. E. GRATZICK, *Dev. Artif. Org.* **7** (1979) 41.
12. M. PATERSON, P. FULFORD and R. DENHAM, *J. B. Jt. Surg.* **B68** (1986) 392.
13. H. C. AMSTUTZ, K. L. MARKOLF, G. M. McNEICE and T. A. GRUEN, in "The Hip" (Mosby, St Louis, 1976).
14. A. S. CARLSSON, C. F. GENTZ and J. STENPORT, *Acta Orthop. Scand.* **48** (1977) 650.
15. S. C. BAYNE, E. P. LAUTENSCHLAGER and C. L. COMPERE, *J. Biomed. Mater. Res.* **9** (1975) 27.
16. S. SAHA and S. PAL, *ibid.* **18** (1984) 435.
17. C. M. RIMNAC and T. M. WRIGHT, *Trans. 31st Ann. Meeting Orthop. Res. Soc.* **10** (1985) 326.
18. M. H. STONE, R. WILKINSON and I. G. STOTHER, *Trans. 13th Ann. Meeting Soc. Biomater.* **10** (1987) 171.
19. J. R. de WIGN, I. J. J. H. SLOOFF and F. C. M. DRIESSENS, *Acta Orthop. Scand.* **46** (1975) 38.
20. M. JASTY, N. F. JENSEN and W. H. HARRIS, *Trans. 2nd World Cong. Biomater. 10th Ann. Meet. Soc. Biomater.* **7** (1984) 46.
21. A. S. GREENWALD, A. H. WILDE and M. B. MATEJCZYK, *Orthop. Digest.* **5** (1977) 16.
22. C. M. RIMNAC, T. M. WRIGHT and D. L. MCGILL, *J. B. Jt. Surg.* **A68** (1986) 281.
23. D. W. BURKE, E. I. GATES and W. H. HARRIS, *Trans. 2nd World Cong. Biomater. 10th Ann. Meeting Soc. Biomater.* **7** (1984) 346.

24. P. C. NOBLE, J. L. JAY, L. J. LINDAHL, J. MALTRY, S. M. DREBEN and H. S. TULLOS, *Trans. 13th Ann. Meeting Soc. Biomater.* **10** (1987) 169.
25. R. L. WIXSON, E. P. LAUTENSCHLAGER and M. NOVAC, *Trans. 31st Ann. Meeting Orthop. Res. Soc.* **10** (1985) 327.
26. S. SAHA and L. WARMAN, *Trans. 2nd World Cong. Biomater., 10th Ann. Meeting Soc. Biomater.* **7** (1984) 48.
27. D. O. O'CONNOR, D. W. BURKE, J. P. DAVIES and W. H. HARRIS, *ibid.* **7** (1984) 45.
28. T. P. HARRIGAN, J. P. DAVIES, D. W. BURKE, D. O. O'CONNOR, J. JASTY and W. H. HARRIS, *Trans. 13th Ann. Meeting Soc. Biomater.* **10** (1987) 170.
29. J. P. DAVIES, D. W. BURKE, D. O. O'CONNOR and W. H. HARRIS, *J. Orthop. Res.* **5** (1987) 366.
30. D. O. O'CONNOR, D. W. BURKE, J. P. DAVIES and W. H. HARRIS, *Trans. 31st Ann. Meeting Orthop. Res. Soc.* **10** (1985) 325.
31. K. C. CHAN, personal communications (1988).
32. J. P. DAVIES, D. O. O'CONNOR, J. A. GREER and W. H. HARRIS, *J. Biomed. Mater. Res.* **21** (1987) 719.
33. J. P. DAVIES, D. O. O'CONNOR and W. H. HARRIS, *Trans. 2nd World Cong. Biomater., 10th Ann. Meeting Soc. Biomater.* **7** (1984) 47.
34. P. EYERER and R. JIN, *J. Biomed. Mater. Res.* **20** (1986) 1057.
35. E. P. LAUTENSCHLAGER, S. I. STUPP and J. C. KELLER, in "Functional Behaviour of Orthopedic Biomaterials", Vol. II, "Applications" (CRC, Boca Raton, Florida, 1984) p. 87.
36. S. A. BROWN and W. L. BARGAR, *J. Biomed. Mater. Res.* **18** (1984) 523.
37. W. L. BARGAR, S. A. BROWN, H. A. PAUL, T. VOEGLI, Y. HSEIH and N. SHARKEY, *J. Orthop. Res.* **4** (1986) 86.
38. A. M. AHMED, R. NAIR, D. L. BURKE and J. MILLER, *J. Biomech. Engng* **104** (1982) 28.
39. C. T. WANG and R. M. PILLIAR, *J. Mater. Sci.* **24** (1989) 2391.
40. B. POURDEYHIMI, H. D. WAGNER and P. SCHWARTZ, *ibid.* **21** (1986) 4468.
41. S. S. HAAS, G. M. BRAUER and G. DICKSON, *J. B. Jt. Surg.* **A57** (1975) 380.
42. B. E. CAUSTON, *J. Dent. Res.* **54** (1975) 339.
43. A. J. C. LEE, R. S. M. LING and S. S. VANGALA, *Arch. Orthop. Traumat. Surg.* **92** (1978) 1.
44. F. A. FREITAG and S. L. CANNON, *J. Biomed. Mater. Res.* **10** (1976) 805.
45. F. LEDNICKY and Z. PELZBAUER, *J. Polym. Sci.* **C38** (1972) 375.
46. P. W. BEAUMONT and R. J. YOUNG, *J. Biomed. Mater. Res.* **9** (1975) 423.
47. P. C. NOBLE, S. M. DREBEN, J. L. JAY and H. S. TULLOS, *Trans. 13th Ann. Meeting Soc. Biomater.* **10** (1987) 366.
48. B. E. STUBBS, L. S. METHUEWS and D. A. SONSTEGARD, *J. B. Jt. Surg.* **A57** (1975) 317.
49. R. G. HILL, J. F. BATES, T. T. LEWIS and N. REES, *J. Mater. Sci.* **19** (1984) 1904.
50. R. G. HILL, J. F. BATES, T. T. LEWIS and N. REES, *Biomater.* **4** (1983) 112.
51. J. SHEN, C. C. CHEN and J. A. SAUER, *Polymer* **26** (1985) 511.
52. G. M. BRAUER and W. T. SWEENEY, *Modern Plastics* **May** (1955) 144.
53. C. C. CHEN, J. SHEH and J. A. SAUER, *Polymer* **26** (1985) 89.
54. D. T. TURNER, *ibid.* **23** (1982) 197.
55. C. MILIARES, L. NICODENO, L. NICOLAIS and P. PASSENI, *J. Biomed. Mater. Res.* **18** (1984) 137.
56. D. J. LAMB and B. ELLIS, British Division IADR Conference, paper 166 (1981).
57. C. T. WANG and R. M. PILLIAR, Bachelor Thesis, University of Toronto (1986).
58. R. P. KUSY, *J. Biomed. Mater. Res.* **12** (1978) 271.
59. D. C. SMITH, *Br. Dent. J.* **111** (1961) 9.
60. W. ROSTOKER, P. LEREIM and J. O. GALANTE, *J. Biomed. Mater. Res.* **13** (1979) 365.
61. M. A. LOONEY and J. B. PARK, *ibid.* **20** (1986) 555.
62. J. J. BENBOW, *Proc. Phys. Soc.* **B78** (1961) 970.
63. A. S. HARGREAVES, *J. Biomed. Mater. Res.* **15** (1981) 757.
64. R. M. PILLIAR, R. VOWLES and D. F. WILLIAMS, *ibid.* **21** (1987) 145.
65. R. M. PILLIAR, D. C. SMITH and B. MARIC, *J. Dental. Res.* **65** (1986) 1308.
66. W. R. KRAUSE and R. S. MATHIS, *Trans. 2nd World Cong. Biomater., 10th Ann. Meeting Soc. Biomater.* **7** (1984) 349.
67. E. I. GATES, D. R. CARTER and W. H. HARRIS, *Clin. Orthop.* **189** (1984) 294.
68. S. C. WEBER and W. L. BARGAR, *Biomater. Med. Dev. Art. Org.* **11** (1983) 3.
69. R. P. ROBINSON, T. M. WRIGHT and A. H. BURSTEIN, *J. Biomed. Mater. Res.* **15** (1981) 203.
70. C. F. STARK, *ibid.* **13** (1979) 339.
71. G. C. SIH and A. T. BERMAN, *ibid.* **4** (1980) 311.
72. T. M. WRIGHT and P. S. TRENT, *J. Mater. Sci.* **14** (1979) 503.

Received 22 August
and accepted 27 September 1988